

 **BURTON**
SECURITY

THE SURE DEFENCE

Armoured Security Doors



Elegance and security

ARMoured SECURITY DOORS

Elegance and security designed for the protection of your family and valuables.

TO BE DEFINED AS “PERFECT” A DOOR NOWADAYS MUST BE SAFE. MUST BE ABLE TO UPDATE THE MOST ADVANCED TECHNOLOGICAL LOCKING SYSTEMS.

IT MUST BE FUNCTIONAL, I.E. CAPABLE OF IMPROVING ITS SECURITY, INSULATING AND ACOUSTIC PERFORMANCE.

FINALLY, IT MUST BE ELEGANT AND CUSTOMISABLE TO RESPOND TO ANY TECHNICAL-AESTHETIC CHOICE.

All our armoured doors have been tested and certified in the laboratory to ensure maximum protection and security from break-in attempts. The ability to resist is measured through the stress with static and dynamic loads, and the simulation of burglary attempts implemented with different types of both manual and electric tools.

In some situations, in addition to protection from burglary attempts, fire protection is required. To meet these needs, we offer two models with fire resistance certification of 30 minutes (Fire 30') or 60 minutes (Fire 60').

Janus Door



METAL+ DOORS
AT THE HEART OF EVERY HEINEN DOOR

KRONOS



Panzer DOORS

JANUS

JANUS SECURITY DOORS



- High security door for homes, offices, banks and prestigious or listed buildings
- Independently attack tested to EN1627 RC3 - RC4
- Custom made to suit your property
- A range of fittings and door furniture available
- High environmental performance - Industry leading energy efficiency
- Superb thermal and sound insulation
- External models offer high levels of air tightness, water resistance and wind resistance
- Choice of key or electronic locking
- Special subframe to aide installation, increase security and can give additional thermal insulation on request
- Security glazing available on request
- Bullet resistance available on request
- Emergency and panic hardware available on request

Locking Options

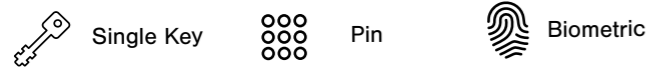

WITH A JANUS DOOR YOU CAN PROTECT WHAT MATTERS MOST TO YOU.

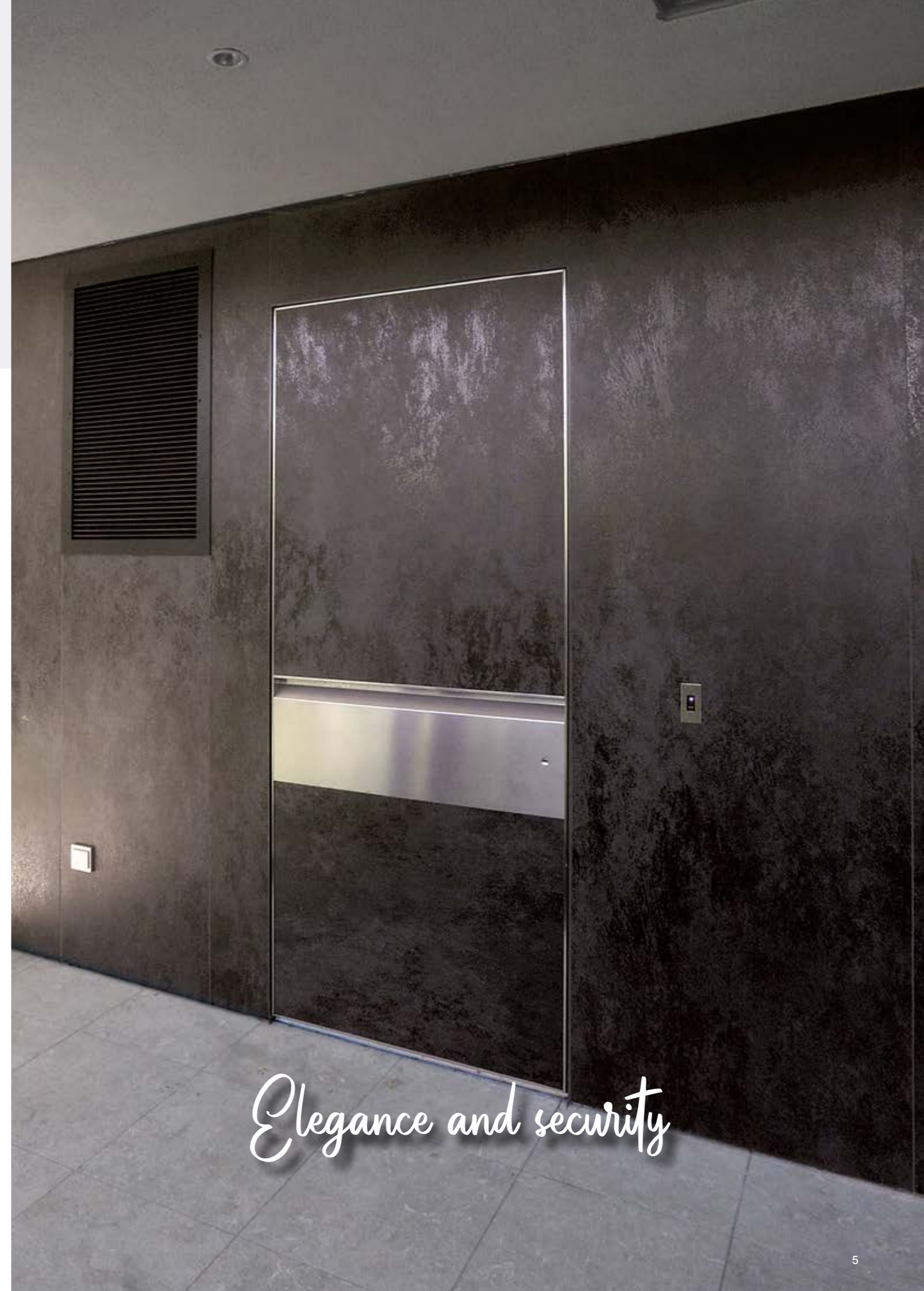
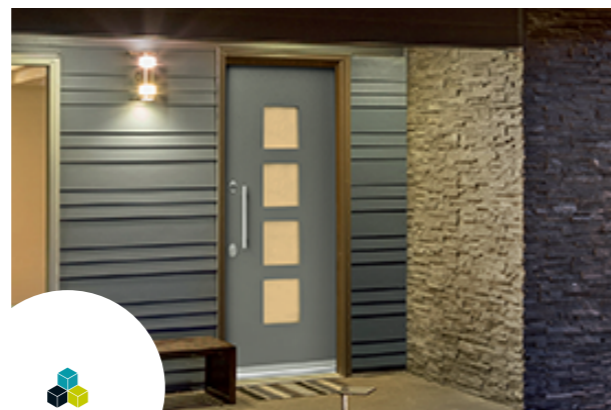

Elegance and security



Outside door view

Door Model	Janus 3	Janus 4	Janus Fire	Janus 3ex	Janus 4ex	Janus Gold	Janus Platinum
Location	Internal	Internal	Internal	External	External	External	External
Security Grade	EN1627 RC3	EN1627 RC4t	EN1627 RC3	EN1627 RC3	EN1627 RC4	EN1627 RC4	EN1627 RC3
Accoustic Insulation	-43dB Rw	-44.8db Rw	-43dB Rw	-44.8dB Rw	-44.8dB Rw	-46dB Rw	-46dB Rw
Thermal Insulation	1.3W/m2K	1.2W/m2K	1.6W/m2K	0.54W/m2K	1.2W/m2K	0.6W/m2K	0.54W/m2K
Air Tightness	N/A	N/A	N/A	Class 4	Class 4	Class 4	Class 4
Water Tightness	N/A	N/A	N/A	Class 6A	Class 3A	Class 9A	Class 9 A
Wind Resistance	N/A	N/A	N/A	Class C4	Class C4	Class 5	Class 5

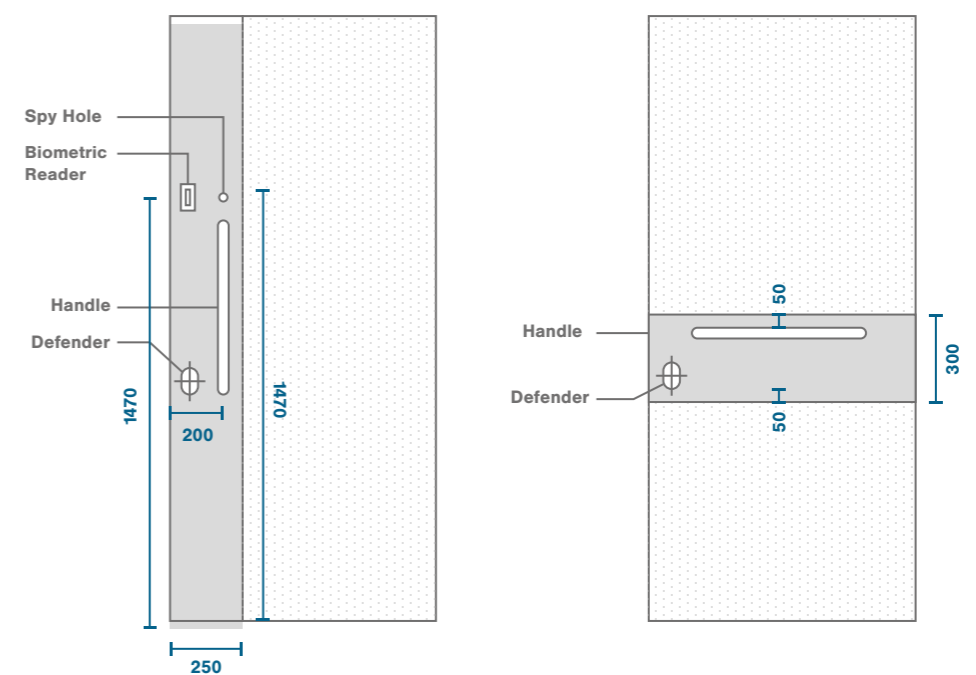



METAL+ DOORS

AT THE HEART OF EVERY HEINEN DOOR

From the simplest to the most demanding requirements



The Heinen heavy duty, high security steel doorsets offer an unrivaled combination of performances. Options include burglary, fire, smoke, bullet & blast resistance, alongside high acoustic & thermal performance as well as options for emergency & panic escape.

The Metal+ steel doors have always remained faithful to their primary objective: to provide protection while guaranteeing stability and robustness that enable heavy-duty use of the door.

Components of the Metal+ door

- Internal tubular steel framework
- Screwed on metal sheets in galvanised or stainless steel
- Adjustable screwed on hinges for precision fitting



The winning combination for a minimal total cost

- Robustness and extreme mechanical resistance
- Very low cost of use : simple to replace components + low maintenance
- Combining high performance features
- 10 or 15 years warranty defined by the installation method

Components of the Metal+ Door

Metal+ Doors have the following basic performance features

- 1 Frame (steel sheet 15/10 or 20/10) covering the thickness of the reveal for an attractive finish (with optional thermal break).
- 2 Double lip seal.
- 3 Insulation around the edges of the door (with intumescent material for fire doors).
- 4 Tubular steel structure (60 x 60 x 2 mm).
- 5 Door skin comprising 15/10 galvanised steel sheet screwed into the tubular structure and individually replaceable.
- 6 Self-lubricating hinges, adjustable and replaceable, screwed into the tubular door structure.
- 7 Hyper-strong synthetic material (for optimum protection of the insulation or intumescent material incorporated into the door leaf).

Combining bespoke performance features

Heinen doors can combine performance features on a bespoke basis. Depending on your needs, one or more performance features are added to the basic, robust METAL+ door.

Fire resistance

EN 1634-1
EI1 30, 60, 120
EI2 30, 60, 120, 180, 240
EW 30, 60, 120, 180, 240
HCM 120/CN240 (N3)

Burglary resistance

EN 1627-1630
RC2, RC3, RC4, RC5
AE20
NF P20-551 & NF P20-311
Niv.5 cat.B / Niv.5 cat.B+

Acoustic performance

EN 717-1: Rw (C; Ctr) dB (A)
36 (-1; -2) to 55 (-2; -7)

Bullet-proof

EN 1522-1523
FB4, FB5, FB6, FB7
AK47

Blast-proof (Only in static calculations)

Electromagnetic shielding (on demand)

Anti-panic EN 179 & EN 1125 (emergency exit devices)

Smoke tightness EN 1634-3 Sa, Sm (200 °C)

Thermal insulation EN 10077-1 & EN 10077-2 Up to 1,5 W/m2K

Airtightness EN 1026 & EN 12207 L1, L2, L3, L4

Watertightness EN 1027 & EN 12208 E0 to E9 + E750

Wind resistance EN 12211 & EN 12210 VC4

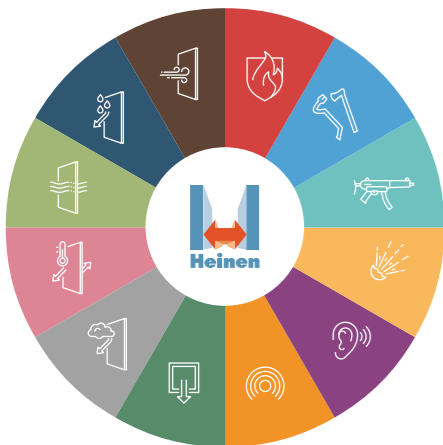
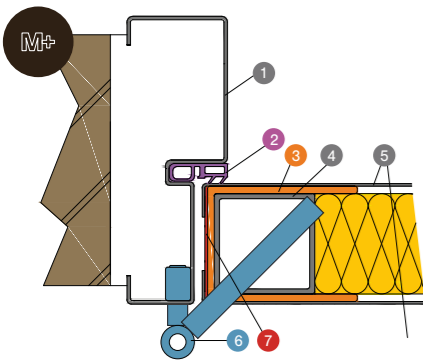

KRONOS SECURITY DOORS

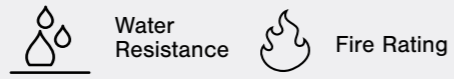

- High security steel doors
- Independently tested and certified to LPS1175 SR2 - SR4
- Optional 240 minutes fire rating*
- Optional flood protection
- Insurance approved by the AiS
- Built to a Police Preferred Specification - Secured by Design
- Suitable for use in any high security environment including; banks, utility sector, retail outlets, jewellers, government, defence buildings and airports
- Custom made to fit your property size and operational requirements
- Inward or outward opening door leaves
- Single or double door sets
- Variety of locking options and optional fittings
- Available in almost any RAL colour**
- 10 year anti-rust warranty



*max 60 minutes with vision panels **some colours are at an additional cost



LPS1175: Issue 7
Cert No: 1000 a



Police Preferred Specification



Variant	Min Height	Max Height	Min Width	Max Width
---------	------------	------------	-----------	-----------

SR2

Single inward opening	1000	2930	600	1430
Double inward opening	1000	2930	900	2600
Single outward opening (with removable over panels)	1000	3930	740	1430
Double outward opening (with removable over panels)	1200	3930	900	2600
Single outward opening	1000	2930	600	1430
Double outward opening	1000	2930	900	2600
Single outward opening (with fixed side and over panels)	1000	3930	740	4180
Double outward opening (with fixed side and over panels)	1200	3930	900	5200

SR3

Single outward opening	1000	2930	600	1430
Double outward opening	1000	2930	900	2600
Single inward opening	1000	2430	600	1430
Double inward opening	1000	2430	900	2600
Single outward opening (with fixed side and over panels)	1200	4125	600	1430
Double outward opening (with removable over panels)	1200	4125	900	2600

SR4

Single outward opening	1000	2930	600	1430
Double outward opening	1000	2930	900	2600
Single inward opening	1000	2430	600	1430



*Blast protection for personnel
and facilities*



PANZER BLAST PROOF DOORS BT



**Our mission is the protection of persons and facilities.
For this purpose we develop and manufacture blast doors and blast equipment in different versions.
The commitment to design and technical precision was instrumental for our company success.**

Panzer Blast Proof Doors BT built in highly efficient design by means mixture of high-quality steel and reinforced concrete.

The BT1, BT2 and BT3 are swing doors with lateral hinges to allow opening from in-and outside.

The doors are tested in the laboratories under real conditions and Simulated calculation by LS-Dyna and certified that they resists a shockwave from up to 9 bar/130 psi till a explosion pressure (reflected pressure) up to 28 bar/406 psi.

The doors can be equipped with an additional emergency door which is operated from both sides.

APPLICATIONS

- Tunneling protect
- Petrochemical industry
- Power plants
- VIP shelters
- Civilian shelters
- Military shelters
- Industrial shelters

**IF IT MATTERS TO YOU,
SECURE IT WITH US...**



LSC LICHFIELD
SAFE CENTRE
UK'S FAVOURITE SAFE
SUPPLIER & INSTALLER

 **BURTON**
SECURITY

Lichfield Safe Centre Ltd.

www.lichfieldsafecentre.co.uk | Telephone 01543 268631 |

Spread Eagle House, 1 Church Street, Lichfield, Staffordshire, WS13 6DZ